



Stainless Steel Series

**2-slice
toaster**

Instruction Manual



Thank You for your purchase

Register & sign up for special
announcements and trendy recipes!

Tell us what you think!
Rate, review or ask us a question.

@bellahousewares.com
#getinspired



BellaLife



BellaLifestyle

Table of Contents

Important Safeguards.....	2-3
Additional Important Safeguards.....	4-5
Notes on the Plug	5
Notes on the Cord.....	6
Plasticizer Warning	6
Electric Power.....	6
Getting to Know Your 2-Slice Toaster.....	7
Automatic Centering Guides.....	8
Before Using for the First Time	8
Toasting Cycles	
TOAST / CANCEL Button.....	9-10
BAGEL Button	10
GLUTEN-FREE Button.....	11
Reheat Cycle	12
Convenience Food Toasting	12
Toaster Pastry	12
Non-Frozen Shelf Pastry.....	12
Removing Lodged Foods.....	13
Important Points	13
User Maintenance Instructions.....	14
Care & Cleaning Instructions.....	14
Storing Instructions	14
Warranty	15-16

IMPORTANT SAFEGUARDS

When using electrical appliances, basic safety precautions should always be followed including the following:

1. **Read all instructions.**
2. Do not touch hot surfaces. Use handles or knobs.
3. To protect against electrical shock do not immerse cord, plugs, or appliance in water or other liquid.
4. This appliance is not intended for use by persons (including children) with reduced physical, sensory or mental capabilities, or lack of experience and knowledge, unless they have been given supervision or instruction concerning use of the appliance by a person responsible for their safety.
5. Close supervision is necessary when any appliance is used by or near children.
6. Unplug from outlet when not in use and before cleaning. Allow to cool before putting on or taking off parts.
7. Do not operate any appliance with a damaged cord or plug or after the appliance malfunctions, or has been damaged in any manner. Return appliance to the nearest authorized service facility for examination, repair or adjustment.
8. The use of accessory attachments not recommended by the appliance manufacturer may cause injuries.
9. Do not use outdoors.
10. Do not let cord hang over edge of table or counter, or touch hot surfaces.
11. Do not place on or near a hot gas or electric burner, or in a heated oven.

- 
12. To disconnect, press the CANCEL button; then remove plug from wall outlet.
 13. Do not use appliance for other than intended use.
 14. Oversized foods, metal foil packages, or utensils must not be inserted in a Toaster as they may involve a risk of fire or electric shock.
 15. A fire may occur if Toasters are covered or touching flammable material, including curtains, draperies, walls, and the like, when in operation.
 16. Extreme caution must be used when moving an appliance containing hot oil or other hot liquids.
WARNING: To prevent electric shock, unplug before attempting to dislodge food or before cleaning.



SAVE THESE INSTRUCTIONS FOR HOUSEHOLD USE ONLY



ADDITIONAL IMPORTANT SAFEGUARDS

CAUTION HOT SURFACES: This appliance generates heat and escaping steam during use. Proper precautions must be taken to prevent the risk of burns, fires, or other injury to persons or damage to property.



1. A person who has not read and understood all operating, toasting, and safety instructions is not qualified to operate this appliance. All users of this appliance must read and understand this instruction manual before operating or cleaning this appliance.
2. If this appliance falls or accidentally becomes immersed in water, unplug it from the wall outlet immediately. Do not reach into the water!
3. When using this appliance, provide adequate air space above and on all sides for air circulation. Do not operate this appliance while it is touching or near curtains, wall coverings, clothing, dishtowels or other flammable materials.
4. To reduce the risk of fire, do not leave this appliance unattended during use.
5. If this appliance begins to malfunction during use, immediately press the CANCEL button and unplug the cord.
Do not use or attempt to repair a malfunctioning appliance!
6. The cord to this appliance should only be plugged directly into a 120V AC electrical wall outlet.
7. Do not use this appliance in an unstable position.

- 
8. Use the 2-Slice Toaster on a hard, flat surface. Do not place it near a flame or heat or on a soft surface (such as carpet). Avoid placing it where it may tip over during use. Dropping the 2-Slice Toaster could cause it to malfunction.
NOTE: This 2-Slice Toaster is equipped with an Anti-Jam feature. If any toast or toaster food gets jammed, the Toaster will shut OFF automatically.

WARNING: ELECTRICAL SHOCK HAZARD. Never attempt to dislodge food inside the 2-Slice Toaster while the Toaster is plugged in. Doing so could cause an electrical shock hazard or a risk of fire.

CAUTION: This appliance is hot during operation and retains heat for some time after turning OFF. Always use oven mitts when handling hot materials and allow metal parts to cool before cleaning. Do not place anything on top of the 2-Slice Toaster while it is operating or while it is hot.

CAUTION!

- 
- DO NOT toast pastries with runny fillings or frosting.
 - DO NOT toast torn slices of bread.
 - DO NOT place buttered bread or wrapped food into the 2-Slice Toaster.
 - DO NOT toast small-size breads, mini-baguettes, breadsticks, etc. in this Toaster.
- 

NOTES ON THE PLUG

This appliance has a polarized plug (one blade is wider than the other). To reduce the risk of electric shock, this plug will fit in a polarized outlet only one way. If the plug does not fit fully into the outlet, reverse the plug. If it still does not fit, contact a qualified electrician.
Do not modify the plug in any way.

NOTES ON THE CORD

- A. A short power-supply cord (or detachable power-supply cord) is to be provided to reduce the risk resulting from becoming entangled in or tripping over a longer cord.
- B. Longer detachable power-supply cords or extension cords are available and may be used if care is exercised in their use.
- C. If a long detachable power-supply cord or extension cord is used:
 - 1. The marked electrical rating of the cord or extension cord should be at least as great as the electrical rating of the appliance;
 - 2. If the appliance is of the grounded type, the extension cord should be a grounding-type 3-wire cord; and
 - 3. The longer cord should be arranged so that it does not drape over the countertop or table top where it can be pulled on by children or tripped over unintentionally.

PLASTICIZER WARNING

CAUTION: To prevent Plasticizers from migrating from the finish of the counter top or table top or other furniture, place NON-PLASTIC coasters or place mats between the appliance and the finish of the counter top or table top. Failure to do so may cause the finish to darken; permanent blemishes may occur or stains can appear.

ELECTRIC POWER

If the electrical circuit is overloaded with other appliances, your appliance may not operate properly. It should be operated on a separate electrical circuit from other appliances.

GETTING TO KNOW YOUR 2-SLICE TOASTER

Product may vary slightly from illustration

1. 2 Toasting Slots
2. 2 Automatic Centering Guides
3. High-Lift Toasting Lever
4. Toasting Lever Slot
5. BAGEL, GLUTEN FREE, CANCEL Buttons
6. 6 Shade Browning Selector Lever with REHEAT Cycle
7. Slide Out Crumb Tray (not shown)
8. Stainless Steel Body
9. Cord Storage Wrap (not shown)
10. Power-Supply Cord with Polarized Plug (not shown)

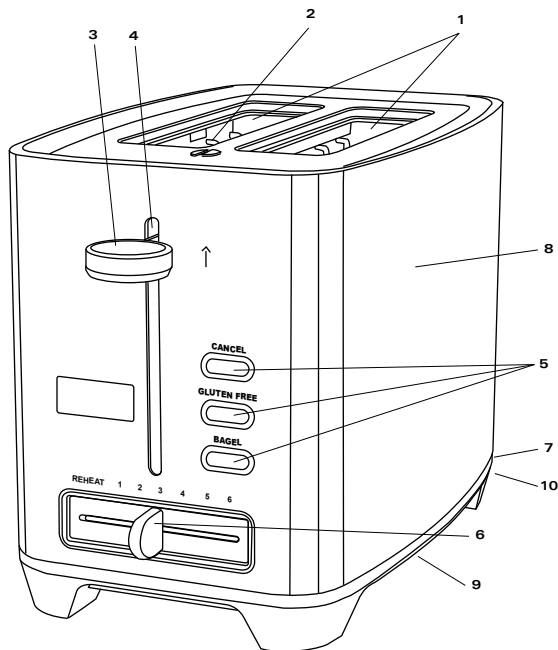

AUTOMATIC CENTERING GUIDES

Lowering the toasting lever closes both centering guides, and holds the bread or toaster food centrally in the toasting slots.

NOTE: The toasting lever will not lock down unless the Toaster is plugged into a 120V AC electrical outlet.

BEFORE USING FOR THE FIRST TIME

1. Remove all packaging materials. Check and clear both toasting slots and the toasting lever slot.
2. Wipe the exterior with a damp cloth. Dry thoroughly. Do not use abrasive cleaners.
3. Do not place the Toaster, cord or plug in water.
4. Make sure the sliding crumb tray is locked in position at the back of the Toaster and the toasting lever is in the UP position.
5. Unwrap power cord from the cord storage area on the underside of Toaster and plug into a 120V AC outlet.
6. Slide the browning selector lever to (1), the lightest setting.
7. Lower the toasting lever until it locks in place. The CANCEL button will illuminate. Operate without bread once or twice to burn off any manufacturing residue. You may notice a slight amount of smoke; this is normal and will stop as the heating elements continue to heat.

TOASTING CYCLES

TOAST / CANCEL BUTTON

1. Make sure the sliding crumb tray is locked in position at the back of the Toaster and the toasting lever is in the UP position.
2. Make sure no bread or other objects are inside the toasting slots. Place Toaster on a flat, level, heat resistant surface.
3. Plug the power cord into a 120V AC electrical outlet.
4. Slide the browning selector lever to the desired setting. To test toasting times for browning, it is best to use both toasting slots; slide the browning selector lever to medium (between 3 and 4); then adjust each subsequent toasting to your preference.
5. Remove all protective wrappings from toaster food before placing into the toasting slot(s).
IMPORTANT: Avoid toasting torn bread slices or small pieces of toaster food that may get lodged in toasting slot(s).
6. **ANTI-JAM Feature.** If any toast or toaster food gets jammed, the Toaster will shut OFF automatically. Unplug the Toaster immediately and allow the Toaster to cool down. Following the procedures outlined in the section entitled "Removing Lodged Foods," clear the jam.

7. Insert bread or toaster food into the toasting slot(s). Lower the toasting lever until locked into place. Automatic centering guides close to hold food upright for uniform side-to-side toasting. When the bread is lowered into position, the CANCEL button will illuminate and toasting will begin.
NOTE: The toasting lever will not lock in position unless the Toaster is plugged into a 120V AC electrical outlet.
NOTE: When toasting a single slice of bread or any toaster food, food may be placed in any toasting slot.
NOTE: To prevent a fire hazard, never place bread or toaster food over the top of the toasting slots; always place bread into the slots.
NOTE: DO NOT change the browning selection during the toasting cycle. First press the CANCEL button; then slide the browning selector lever to adjust the browning. Lower the toasting lever and continue toasting.



- 
8. When the toasting time elapses, toast or toaster food will rise automatically. Use the high-lift lever to make it easier to remove smaller toasted items. Push the toasting lever manually UP to the top of the toasting slot and carefully removed toasted food. Use care as the bread and the top of the Toaster will still be hot.
IMPORTANT: Never use a fork or sharp-edged utensil to remove toast, because that may damage the heating element or cause injury.
 9. Unplug cord from wall outlet when not in use.

CANCEL BUTTON

1. When the toasting lever is lowered, the CANCEL button will illuminate and toasting will begin.
2. To stop or interrupt any toasting cycle, press the CANCEL button. Bread, bagels or toaster food will automatically rise; the Toaster will turn OFF.
3. Unplug cord from wall outlet when not in use.

BAGEL BUTTON

The bagel cycle works great for English muffins, too!

- 
1. Place one half in each toasting slot with the cut sides facing the center.
 2. Slide the browning selector lever to the desired setting.
 3. Press the toasting lever down. The CANCEL button will illuminate.
 4. Press the BAGEL button. The bagel button will illuminate. BAGEL toasting will begin.
 5. When the toasting time elapses, the toasted bagel will rise automatically. Use care as the bagel and the top of the Toaster will still be hot.
 6. To stop or interrupt the BAGEL cycle, press the CANCEL button. The toasted bagel will automatically rise; the Toaster will turn OFF.
 7. Unplug cord from wall outlet when not in use.
- 

GLUTEN FREE BUTTON

Use your Toaster to toast or reheat fresh or defrosted Gluten-free bread, bagels and waffles, and more! Gluten-free breads are often denser in quality and require a longer toasting time. The gluten free cycle adjusts and adds the ideal amount of time to your toasting cycle to ensure perfect browning.

1. Place gluten free bread, bagel or waffle into 1 or both toasting slots.
2. Slide the browning selector lever to the desired setting.
3. Press the toasting lever down. The CANCEL button will illuminate.
4. Press the GLUTEN FREE button. The GLUTEN FREE button will illuminate. GLUTEN FREE toasting will begin.
5. When the toasting time elapses, the toast or toaster food will rise automatically. Use the high-lift lever to make it easier to remove smaller toasted items. Use care as the bread and the top of the Toaster will still be hot.
6. When using gluten free bagels, press the GLUTEN FREE button first and then BAGEL button. When both buttons are pressed the GLUTEN FREE and BAGEL buttons will illuminate and toasting will begin. The toasting time is adjusted to give the same degree of browning achieved with bagels.
7. To stop or interrupt the GLUTEN FREE cycle, press the CANCEL button. Bread or toaster food will automatically rise; the Toaster will turn OFF.
8. Unplug cord from wall outlet when not in use.

REHEAT CYCLE

Use this cycle to reheat toast, bagels, waffles, or toaster foods without further browning.

1. Replace the toast, waffles, or toaster food into 1 or both toasting slots.
2. Slide the browning selector lever to REHEAT, the lowest setting.
3. Press the toasting lever down. The CANCEL button will illuminate. REHEATING will begin.
4. When the REHEAT time elapses, toast or toaster food will rise automatically. Use the high-lift lever to make it easier to remove smaller toasted items. Use care as the toast and the top of the Toaster will still be hot.
5. To stop or interrupt, press the CANCEL button. Bread or toaster food will automatically rise; the Toaster will turn OFF.
6. Unplug cord from wall outlet when not in use.

CONVENIENCE FOOD TOASTING

Many varieties of packaged convenience foods are available today, both frozen and non-frozen (shelf pastry). Always refer to the heating instructions on convenience food packaging. Since toaster foods and individual tastes vary, it is difficult to recommend exact browning selector settings. After some experimentation, you will discover the best setting for your needs.

TOASTER PASTRY

For best results, follow the instructions printed on the pastry package. If the package does not have instructions, slide the browning selector lever to medium (between 3 and 4). Some pastries may require a second toasting cycle.

NOTE: Do not use this Toaster for toasting pastry items with runny-type frosting or open fillings.

NON-FROZEN SHELF PASTRY

Slide the browning selector lever to a lighter setting. For thicker convenience foods, it may be necessary to adjust the browning selector lever to a higher setting and a longer toasting cycle.

REMOVING LODGED FOODS

1. Use the high-lift lever to make it easier to remove smaller toasted items. Push the toasting lever manually UP to the top of the toasting slot. Use care as the toast and the top of the Toaster will still be hot.
2. If, after toasting, a piece of bread or any other toaster food becomes lodged in any of the toasting slots, unplug the Toaster and allow it to cool.
3. Hold the toasting lever down. Turn the Toaster upside down and shake the food loose. **IMPORTANT:** Never use a fork or sharp-edged utensil to remove toast, because that may damage the heating element or cause injury.

IMPORTANT POINTS

- Make sure the sliding crumb tray is locked in position at the back of the Toaster and the toasting lever is in the UP position before plugging in or unplugging Toaster from the electrical outlet.
- Remove all protective wrappings from food before placing into the toasting slot(s).
- For best results, clean the crumb tray frequently.
- Different breads and toaster foods require different color settings. Press the CANCEL button at any time to check browning progress.
- Do not block any toasting slot. Do not place any object over any toasting slot.
- Do not toast buttered bread or buttered muffins. Melted butter will cause fire.
- When toasting more than one slice of bread, use slices of similar size, thickness and freshness.
- Stale bread, thin bread or sweet bread products, such as tea cakes and fruit loaf, brown much more quickly than ordinary bread, so they should be toasted on the lighter settings.
- Never immerse Toaster, cord or plug in water or other liquid.
- Never use a fork or sharp-edged utensil to remove toast! Damage to the heating element may cause injury and damage to the Toaster.
- To use the high-lift lever, push the toasting lever manually UP to the top of the toasting slot.
- **NOTE: The gluten free cycle does not remove the gluten from your bread.**



USER MAINTENANCE INSTRUCTIONS

This appliance requires little maintenance. It contains no user-serviceable parts. Any servicing requiring disassembly other than cleaning must be performed by a qualified appliance repair technician.

CARE & CLEANING INSTRUCTIONS

CAUTION: Do not immerse Toaster, cord, or plug in water or any other liquid.

CAUTION: Be sure the Toaster is unplugged before cleaning.

CRUMB TRAY: Slide the crumb tray out from the back of the Toaster. Working over a sink or garbage receptacle, wipe the crumb tray with a clean, damp cloth. Slide crumb tray back into position. Make sure it is locked securely into position at the back of the Toaster.

EXTERIOR: Wipe the Toaster's exterior with a clean, damp cloth. If necessary, use a stainless steel cleaner to polish. Do not use abrasive cleaners. Do not put cord, or plug in water or liquid.

STORING INSTRUCTIONS

1. Unplug unit, allow to cool, and clean before storing. Never store Toaster while it is hot or still plugged in.
2. Make sure clean crumb tray is locked securely into position at the back of the Toaster.
3. Wrap the cord around the cord storage area located on the bottom of the Toaster. Do not put any stress on the cord where it enters the unit, as it could cause the cord to fray and break.
4. Store Toaster in its box in a clean, dry place.



Limited Two-Year Warranty

SENSIO Inc. hereby warrants that for a period of **TWO YEARS** from the date of purchase, this product will be free from mechanical defects in material and workmanship, and for 90 days in respect to non-mechanical parts. At its sole discretion, SENSIO Inc. will either repair or replace the product found to be defective, or issue a refund on the product during the warranty period.

Exclusions:

The warranty does not cover normal wear of parts or damage resulting from any of the following: negligent use of the product, use of improper voltage or current, improper routine maintenance, use contrary to the operating instructions, disassembly, repair, or alteration by anyone other than qualified SENSIO Inc. personnel. Also, the warranty does not cover Acts of God such as fire, floods, hurricanes, or tornadoes.

SENSIO Inc. shall not be liable for any incidental or consequential damages caused by the breach of any express

The warranty is only valid for the original retail purchaser from the date of initial retail purchase and is not transferable. Keep the original sales receipt, as proof of purchase is required to obtain warranty validation. Retail stores selling this product do not have the right to alter, modify, or in any way revise the terms and conditions of the warranty.

or implied warranty. Apart from the extent prohibited by applicable law, any implied warranty of merchantability or fitness for a particular purpose is limited in time to the duration of the warranty. Some states, provinces or jurisdictions do not allow the exclusion or limitation of incidental or consequential damages, or limitations on how long an implied warranty lasts, and therefore, the above exclusions or limitations may not apply to you. The warranty covers specific legal rights which may vary by state, province and/or jurisdiction.

How To Obtain Warranty Service:

You must contact Customer Service at our toll-free number: 1-866-832-4843. A Customer Service Representative will attempt to resolve warranty issues over the phone. If the Customer Service Representative is unable to resolve the problem, you will be provided with a case number and asked to return the product to SENSIO Inc. Attach a tag to the product that includes: your name, address, daytime contact telephone number, case number, and description of the problem.

Also, include a copy of the original sales receipt. Carefully package the tagged product with the sales receipt, and send it (with shipping and insurance prepaid) to SENSIO Inc.'s address. SENSIO Inc. shall bear no responsibility or liability for the returned product while in transit to SENSIO Inc.'s Customer Service Center.





For customer service questions or comments
1-866-832-4843
bellahousewares.com

BELLA Pro Series is a registered trademark of Sensio Inc., Montreal, Canada H3B 3X9.
All rights reserved.

SO-315435