



Stainless Steel Series

**Steam
Espresso Maker**

Instruction Manual



Thank You for your purchase

Register & sign up for special
announcements and trendy recipes!

Tell us what you think!
Rate, review or ask us a question.

@bellahousewares.com
#getinspired



BellaLife



BellaLifestyle

Table of Contents

Important Safeguards.....	1-3
Additional Important Safeguards.....	3-5
Notes on the Plug.....	6
Notes on the Cord.....	6
Plasticizer Warning.....	6
Electric Power.....	6
Getting to Know Your Espresso Maker.....	7
Safety Warnings.....	8
Before Using for the First Time.....	8
Brewing Espresso.....	8-9
Preparing Cappuccino.....	10
User Maintenance Instructions.....	11
Care & Cleaning Instructions.....	11
Descaling.....	12
Storing Instructions.....	13
Warranty.....	14

IMPORTANT SAFEGUARDS

When using electrical appliances, basic safety precautions should always be followed including the following:

1. **Read all instructions.**
2. Do not touch hot surface. Use handles or knobs only.
3. This appliance is not intended for use by persons (including children) with reduced physical, sensory or mental capabilities, or lack of experience and knowledge, unless they have been given supervision or instruction concerning use of the appliance by a person responsible for their safety.
4. Close supervision is necessary when any appliance is used by or near children.
5. In order to minimize the risk of property damage, never place the Coffee Maker under cabinets. Make sure the area several feet above the Coffee Maker is clear from all furniture or cabinetry.
6. Do not open water tank lid while coffee is brewing. Scalding may occur if the water tank lid is removed during the brewing cycle.
7. Do not use outdoors.
8. Unplug unit from outlet when not in use and before cleaning. Allow unit to cool before putting on or taking off parts, and before cleaning.
9. To protect against fire, electrical shock and injury to persons, do not immerse cord, plugs, or appliance in water or other liquids.

10. Do not operate any appliance with a damaged cord or plug, or after the appliance malfunctions, or has been damaged in any manner. Return appliance to the nearest authorized service facility for examination, repair or adjustment.

**NOTE: DO NOT ATTEMPT TO REPAIR THE UNIT YOURSELF.
THIS WILL VOID THE WARRANTY.**

11. The use of accessory attachments not recommended by the appliance manufacturer may result in fire, electric shock or injury to persons.
12. Never move the appliance by pulling the cord. Do not let the cord hang over the edge of a table or counter or touch hot surfaces.
13. Stand the appliance on a table or flat surface.
14. Do not use a cracked glass carafe or a carafe having a loose or weakened handle.
15. Only use the glass carafe with this appliance. Handle with care as the glass is very fragile.
16. Snap lid securely onto glass carafe before serving coffee.
17. Never use your Coffee Maker without water in it.
18. Do not place appliance on or near a hot gas or electric burner or in a heated oven.
19. The carafe is designed for use with this appliance. It must never be used on a range top.
20. Do not set hot glass carafe on a wet or cold surface.
21. Do not clean glass carafe with cleaners, steel wool pads, or other abrasive material.
22. Do not use this appliance for other than its intended use.
23. Scalding may occur if the lid is removed during the brewing cycles.

24. To reduce the risk of fire, do not mount unit over or near any portion of a heating or cooking appliance.
25. To reduce the risk of electric shock, do not mount over a sink.
26. To reduce the risk of fire, do not store anything directly on top of the appliance surface when the appliance is in operation.
27. To reduce the risk of Fire or Electric Shock, do not remove bottom cover.
No user serviceable parts inside. Repair should be done by authorized service personnel only.

FOR HOUSEHOLD USE ONLY



ADDITIONAL IMPORTANT SAFEGUARDS

WARNING: This appliance generates heat and escaping steam during use. Proper precautions must be taken to prevent the risk of burns, fires, or other injury to persons or damage to property.

CAUTION: The Espresso Maker must be allowed to cool down sufficiently before adding more water to avoid splattering.

1. All users of this appliance must read and understand this Instruction Manual before operating or cleaning this appliance.
2. The cord to this appliance should be plugged into a 120V AC electrical outlet only.

3. Use water only in this appliance! Do not put any other liquids or food products in this appliance. Do not mix or add anything to the water placed in this appliance, except as instructed in the Descaling section of this Instruction Manual.
4. DO NOT attempt to move an appliance containing hot liquids. Allow appliance to cool completely before moving.
5. Keep appliance at least 4 inches away from walls or other objects during operation.
6. Place the appliance on a surface that is resistant to heat.
7. If this appliance begins to malfunction during use, turn function knob to OFF, then immediately unplug the cord. Do not use or attempt to repair the malfunctioning appliance.
8. If this appliance falls or accidentally becomes immersed in water or any other liquid, unplug it immediately. Do not reach into the water! Do not use this appliance after it has fallen into or has become immersed in water. Contact Consumer Service for examination and repair.
9. Always use fresh, cool water in your appliance. Warm water or other liquids, except as described in the descaling section, may cause damage to the appliance.
10. Turn the control knob to OFF and unplug from the electrical outlet when not in use and before cleaning. Allow to cool before putting on or taking off parts and before cleaning the appliance.
11. DO NOT remove the reservoir cap or brew basket until pressure is completely relieved.

12. **CAUTION: PRESSURE.** In order to check if the appliance is under pressure, follow these steps:
- a. Turn the function knob to the OFF position and unplug the appliance.
 - b. Rotate the function knob to the  (steam) position. If steam comes out of the Steam Wand, then the water reservoir is still under pressure.
 - c. To release the pressure, hold a pitcher of water under the Steam Wand and immerse the Steam Wand in the water. SLOWLY TURN THE FUNCTION KNOB TO THE  (STEAM) POSITION AND RELEASE THE STEAM.
 - d. When the steam wand stops releasing steam, turn the Function Knob to the OFF position and slowly remove the cap.
 - e. Do not remove the Filter Basket at any time during the brewing process or until pressure is relieved.
 - f. Use caution when removing the filter basket. The metal parts may still be very hot. Also, there may be hot water floating on the top of the filter.
 - g. If coffee does not drip from basket, the brew basket is blocked. Allow the ppliance to cool down, then release the steam with the instructions above.
The blockage may be caused by too finely ground coffee.
 - h. When cleaning the steam wand, place a frothing pitcher or large cup half full of water under the steam wand. Make sure the tip of the frothing tube is submerged in liquid before turning the function knob to the  (steam) position.

SAVE THESE INSTRUCTIONS

NOTES ON THE PLUG

This appliance has a polarized plug (one blade is wider than the other). To reduce the risk of electric shock, this plug will fit in a polarized outlet only one way. If the plug does not fit fully into the outlet, reverse the plug. If it still does not fit, contact a qualified electrician. Do not modify the plug in any way.

NOTES ON THE CORD

The provided short power-supply cord should be used to reduce the risk resulting from becoming entangled in or tripping over a longer cord. Do not use an extension cord with this product.

PLASTICIZER WARNING

CAUTION: To prevent Plasticizers from migrating to the finish of the counter top or table top or other furniture, place NON-PLASTIC coasters or place mats between the appliance and the finish of the counter top or table top. Failure to do so may cause the finish to darken; permanent blemishes may occur or stains can appear.

ELECTRIC POWER

If the electrical circuit is overloaded with other appliances, your appliance may not operate properly. It should be operated on a separate electrical circuit from other appliances.

GETTING TO KNOW YOUR ESPRESSO MAKER

Product may vary slightly from illustration

1. Water Tank Safety Lid
2. Function Knob
 - ☁ (steam)
 - OFF
 - ☕ (espresso)
3. POWER Light
4. Water Tank
5. Brew Head (not shown)
6. Glass Carafe with Lid
7. Drip Tray
8. Warming Tray
9. Steam Wand
10. "Perfect Froth" Tip
11. Removable Drip Tray Cover
12. Measuring Spoon
13. Filter Basket
14. Filter Basket Holder
15. Nozzle
16. Security Clip
17. Handle

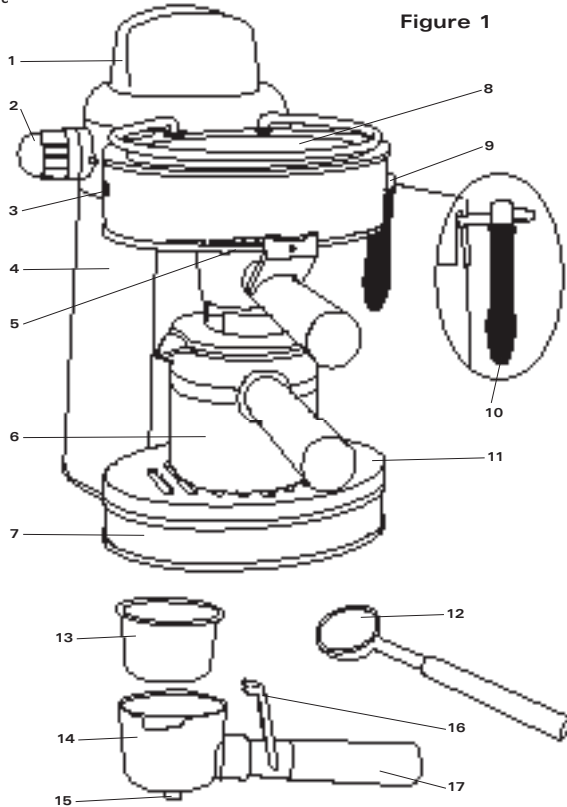

Safety Warnings



- Proper precautions must be made to avoid burns from sprays of hot water or steam.
- Avoid touching any hot surfaces on the machine or any parts of the filter basket holder, filter basket, or any parts of the steam wand while the Espresso Maker is in use or after it is just been used to prepare hot beverages.
- To avoid water spillage, it is necessary to wipe the drip tray clean. Lift the drip plate up and off the unit. Empty water, wipe dry, and replace drip plate.

BEFORE USING FOR THE FIRST TIME

1. Before brewing your first cup of espresso, we suggest you pre-clean the machine. Place the Espresso Maker on a level surface, within close proximity to a sink to discard water.
2. Make sure the Espresso Maker is unplugged.
3. Brew 2 carafes of water without coffee, following the procedures outlined in the Brewing Espresso section of this Instruction Manual. This will thoroughly clean the unit.

BREWING ESPRESSO

1. Make sure the function knob is in the OFF position. Plug the Espresso Maker into a 120V AC electrical outlet. The blue POWER light should be off.
2. Remove the water tank safety lid by turning it counter-clockwise.
3. To brew fresh espresso, fill glass carafe with 2 to 4 cups of cold water, using the markings on the carafe for reference. Pour water into the water tank.
4. Turn the water tank safety lid clockwise until it is tightly sealed.
5. If the filter basket holder is locked into the Espresso Maker, remove from the brew head. Grasp the handle firmly and turn clockwise until the handle faces the left, unlocked position. The filter basket holder will drop down and out from the brew head.
6. With the measuring spoon, measure ground espresso coffee and place into the filter basket until the "4" level mark indicated inside the filter. Gently tamp the coffee to pack it. To assure a proper fit into the Espresso Maker's brew head, do not add coffee above this "4" level mark. **For best results**, use MEDIUM to FINE (espresso) ground coffee.

7. Place the filter basket into the filter basket holder.
8. Align the filter basket holder with slots up in the Espresso Maker's brew head. Turn handle counter-clockwise (to the right) until the filter basket holder is securely locked.
9. Place the cover on the carafe and return the carafe to the Drip Tray Cover. Align hole in lid under nozzle.
10. Turn the function knob to  (espresso). The blue POWER light will illuminate.
11.
 - a. When brewing only 4 cups of espresso (4 cups of water will be added into the water tank), espresso will begin to flow into the carafe after approximately 2 minutes.
 - b. When brewing 4 cups of cappuccino (4 cups of water + 1 steam  level of water will be added into the water tank), espresso will begin to flow into the carafe after approximately 3 minutes.
12. When the coffee has stopped flowing into the carafe, turn the function knob to OFF. The blue POWER light will turn off.
13. To refill the water tank for additional servings, make sure the water tank is cooled and empty and the blue POWER light is off.

CAUTION: This Espresso Maker will continue to heat water under pressure until the water tank is empty. Before removing the Filter Holder, or the water tank safety lid, turn the function knob to  (steam) . When no further steam is emitted from the steam jet, turn the function knob OFF. The blue POWER light will turn off.



CAUTION: To avoid scalding or burns, do not open the water tank safety lid or remove the Filter Holder during the brewing process, or when the blue POWER light is illuminated.

PREPARING CAPPUCCINO

Cappuccino is a delicious blend of espresso, steamed milk and frothed milk.

CAUTION: To avoid scalding or burns, do not open the water tank safety lid or remove the Filter Holder during the brewing process or when the POWER light is illuminated.

NOTE: To prepare 4 cups of cappuccino, fill the carafe with 4 cups of cool, clean water for espresso + 1 steam  level of water for steaming.

1. Follow the detailed procedures for brewing espresso outlined in this Instruction Manual. This should be added making reference to the previous espresso description.
2. While espresso coffee is brewing, fill a deep, metal or ceramic pitcher half full with fresh, cold skim milk and place it next to the Espresso Maker.
3. Once espresso coffee has finished brewing to the desired 4 cup mark on the Glass Carafe, turn the function knob to OFF.
4. Hold the pitcher by the handle and bring up to the steam jet. Insert the “Perfect Froth” tip just under the surface of the milk. Turn the function knob gradually to  (steam). Move the pitcher in a slightly circular motion, and continue to froth the milk.
REMINDER: To avoid splattering, the tip must remain just under the surface of the milk. Otherwise, splattering may occur.
IMPORTANT: When frothing milk, the volume of milk will double. The top half will be frothed, the bottom half will be milk.
5. After frothing, turn the function knob back to OFF.
6. Remove the pitcher from the steam jet.
CAUTION: Before removing the Filter Holder, or the water tank safety lid, turn the function knob to  (steam) and wait until no further steam is emitted from the steam jet. This will allow any extra steam to be released and will clean the steam jet of any excess milk. Then turn the function knob back to the OFF position.
7. Fill a cappuccino cup 1/3 full of freshly brewed espresso. Pour in an equal amount of warm milk and spoon frothed milk on top.
8. Dust froth with cocoa powder, fresh grated nutmeg or cinnamon and enjoy a delicious, freshly brewed cappuccino.

USER MAINTENANCE INSTRUCTIONS

This appliance requires little maintenance. It contains no user serviceable parts. Do not try to repair it yourself. Any servicing requiring disassembly must be performed by a qualified appliance repair technician.

CARE & CLEANING INSTRUCTIONS

CAUTION: NEVER IMMERSE THE ESPRESSO MAKER IN WATER OR ANY OTHER LIQUID.

1. Unplug the Espresso Maker from the electrical outlet and allow to cool completely before cleaning.
CAUTION: The Espresso Maker creates hot water and steam under pressure. To avoid burns on fingers or hands, always make sure the POWER light is off. NEVER touch the filter basket holder or steam wand immediately after brewing or steaming. Allow all parts to cool thoroughly before touching.
IMPORTANT: The filter basket holder and filter basket should be emptied and rinsed thoroughly with warm water after every use.
2. Grasp the filter basket holder handle firmly and turn clockwise until the handle faces the left, unlocked position. The filter basket holder will drop down and out of the unit.
3. Remove the filter basket and empty the used coffee grounds.
4. If necessary, clean the filter basket with a kitchen brush. A pin may be used to clear clogged holes of either filter basket or the steam wand. Dry thoroughly.
5. Remove the drip plate. Empty water from drip tray. Dry with a clean cloth.
6. Rinse and replace clean drip plate.
7. Wipe the outside of the Espresso Maker and the steam wand with a damp cloth.
WARNING: Never use solvents or any detergents that may scratch or damage the surface of the machine.
8. Clean the carafe and carafe lid with warm, soapy water. Handle with extreme care, as glass will become slippery when wet.

DESCALING

Minerals and calcium found in hard-water areas can accumulate and affect the operation of your machine. Depending on water conditions and frequency of use, your Espresso Maker should be cleaned with distilled vinegar approximately every 6 months to remove scale.

1. Before cleaning your Espresso Maker, make sure the function knob is in the OFF position and the appliance has been disconnected from the wall outlet.
2. Fill the carafe with 1 part white vinegar to 3 parts cold water. Pour water and vinegar solution into the water reservoir.
3. Securely fasten the water tank safety lid.
4. Attach empty coffee filter basket and holder.
5. Place carafe onto drip plate.
6. Plug the Espresso Maker into 120V AC electrical outlet.
7. Turn function knob to ☐^{sss} (espresso). In a few minutes, the hot vinegar will start to flow through the coffee basket into the carafe.
8. Place steam jet into a tall glass or mug. Move function knob to ☐^u (steam) position during the flowing to clean any residue left in the tube from the milk steaming process.
9. Turn function knob back to ☐^{sss} (espresso), permitting the hot vinegar to continue to flow in the carafe.
10. When the flow has stopped, turn function knob to OFF position and allow to cool completely. Make sure the POWER light is off. Then remove filter basket holder, carafe and rinse with hot water.
11. Repeat above steps using cold water to rinse any residual vinegar. Repeat twice.
12. Unplug the Espresso Maker from the wall outlet.

STORING INSTRUCTIONS

1. Make sure unit is unplugged and fully cooled before storing.

WARNING: Never store Espresso Maker while it is hot or still plugged in.

2. Do not put any stress on cord where it enters unit, as this could cause cord to fray and break.
3. Store the Espresso Maker in its box, in a clean, dry area.

Limited Two-Year Warranty

SENSIO Inc. hereby warrants that for a period of **TWO YEARS** from the date of purchase, this product will be free from mechanical defects in material and workmanship, and for 90 days in respect to non-mechanical parts. At its sole discretion, SENSIO Inc. will either repair or replace the product found to be defective, or issue a refund on the product during the warranty period.

Exclusions:

The warranty does not cover normal wear of parts or damage resulting from any of the following: negligent use of the product, use of improper voltage or current, improper routine maintenance, use contrary to the operating instructions, disassembly, repair, or alteration by anyone other than qualified SENSIO Inc. personnel. Also, the warranty does not cover Acts of God such as fire, floods, hurricanes, or tornadoes.

SENSIO Inc. shall not be liable for any incidental or consequential damages caused by the breach of any express

The warranty is only valid for the original retail purchaser from the date of initial retail purchase and is not transferable. Keep the original sales receipt, as proof of purchase is required to obtain warranty validation. Retail stores selling this product do not have the right to alter, modify, or in any way revise the terms and conditions of the warranty.

or implied warranty. Apart from the extent prohibited by applicable law, any implied warranty of merchantability or fitness for a particular purpose is limited in time to the duration of the warranty. Some states, provinces or jurisdictions do not allow the exclusion or limitation of incidental or consequential damages, or limitations on how long an implied warranty lasts, and therefore, the above exclusions or limitations may not apply to you. The warranty covers specific legal rights which may vary by state, province and/or jurisdiction.

How To Obtain Warranty Service:

You must contact Customer Service at our toll-free number: 1-866-832-4843. A Customer Service Representative will attempt to resolve warranty issues over the phone. If the Customer Service Representative is unable to resolve the problem, you will be provided with a case number and asked to return the product to SENSIO Inc. Attach a tag to the product that includes: your name, address, daytime contact telephone number, case number, and description of the problem.

Also, include a copy of the original sales receipt. Carefully package the tagged product with the sales receipt, and send it (with shipping and insurance prepaid) to SENSIO Inc.'s address. SENSIO Inc. shall bear no responsibility or liability for the returned product while in transit to SENSIO Inc.'s Customer Service Center.



For customer service questions or comments
1-866-832-4843
bellahousewares.com

BELLA Pro Series is a registered trademark of Sensio Inc., Montreal, Canada H3B 3X9.
All rights reserved.

SO-315387_R01